

Kod wyrobu: W-CR-000018

Elementy: Podstawka SKP L1240

Waga: 1,7 kg

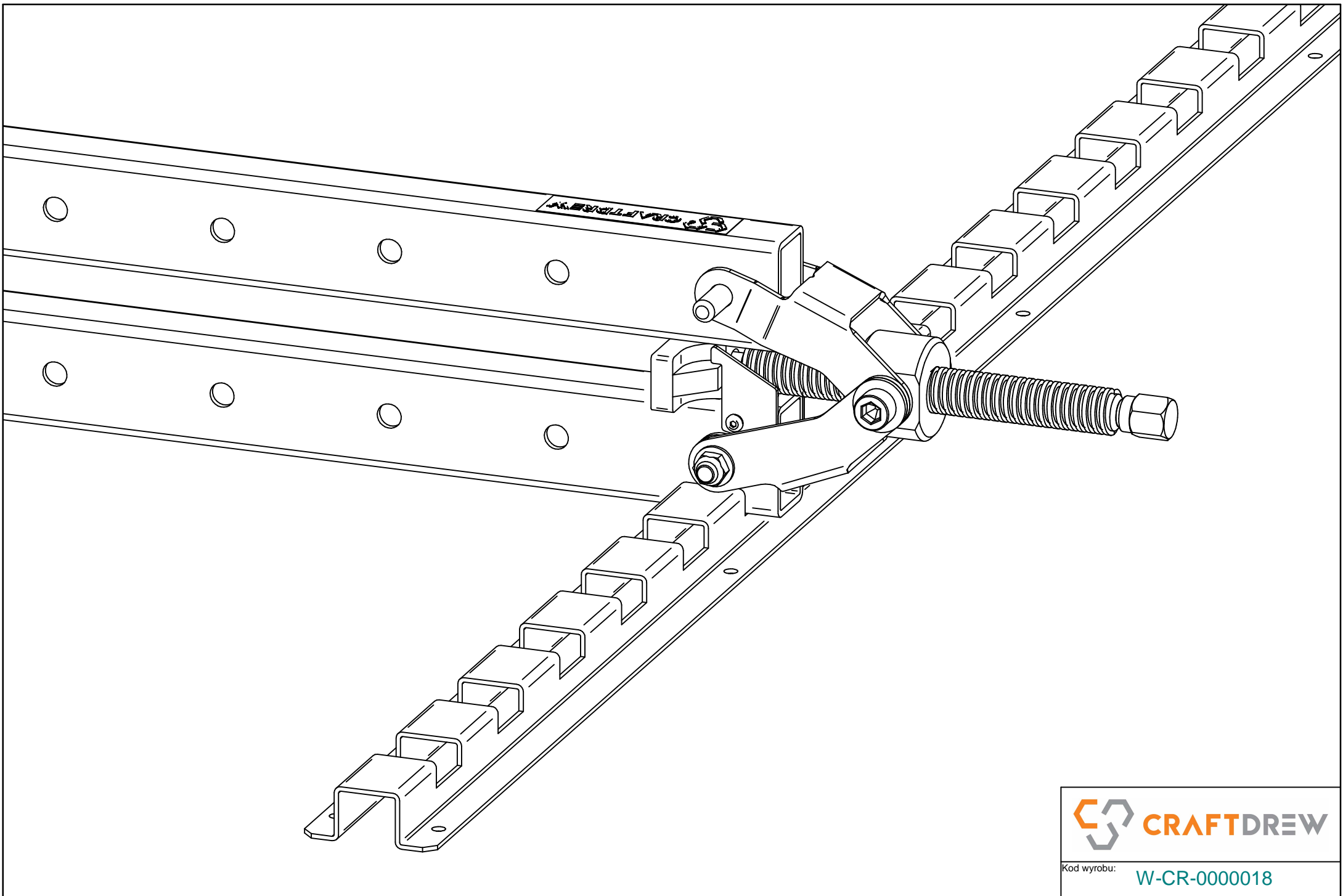

Kod wyrobu: W-CR-000018

Waga: 1,7 kg

Elementy: Podstawka SKP L1240